

D Sistem Dış Çap Kater / D System External Turning Holders
D System Klemmalter

50° DCMNN

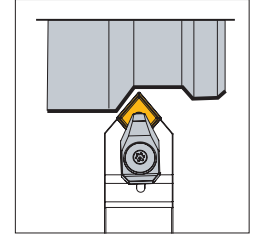
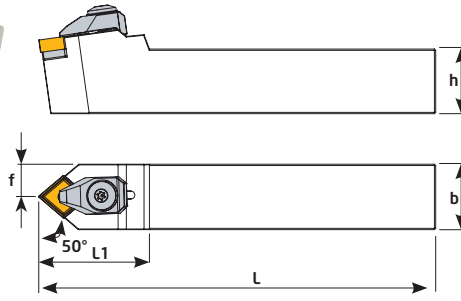

Sipariş Kodu Order Code Best.-Nr.	Stok/Stock/Lager	Ürün Kodu Product Code Produkt-Code	Ölçüler (mm) Dimensions (mm) Abmessungen (mm)						Kullanılan Uç Insert WSP	Baskı Civatası Locking Screw Verriegelungs Schraube	Altlık Shim U-Platte	Altlık Civatası Shim Screw U-Platte Schraube	Baskı Kepi Clamp Spannpratze	Yay Spring Feder	Pul Washer U-Scheibe	Anahtar Allen Key Inbuss-Schlüssel
			L	L1	h	f	b									
D214-1	●	DCMNN 2020 K12	125	35	20	10	20	0,445	CN-- 1204	TC044 M6	TA016	TC038 M4x10	BK020	BY040	BSP030	4 Allen
D215	●	DCMNN 2525 M12	150	42	25	12,5	25	0,778								

45° DCSNR

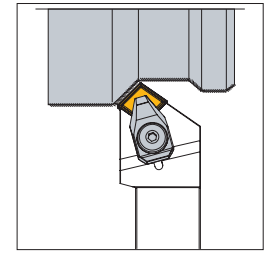
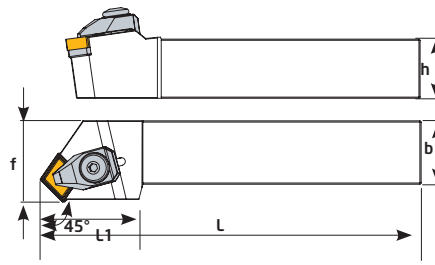

D218	●	DCSNR 2525 M12	150	35	25	32	25	0,774	CN-- 1204	TC044 M6	TA016	TC038 M4x10	BK020	BY040	BSP030	4 Allen
------	---	----------------	-----	----	----	----	----	-------	-----------	----------	-------	-------------	-------	-------	--------	---------

40° DCXNN

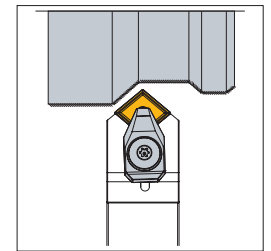
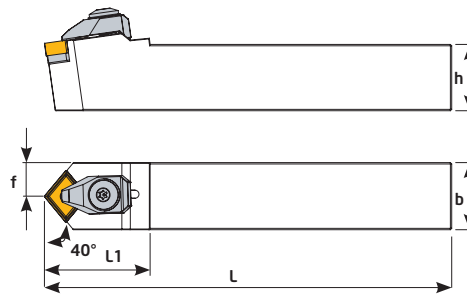
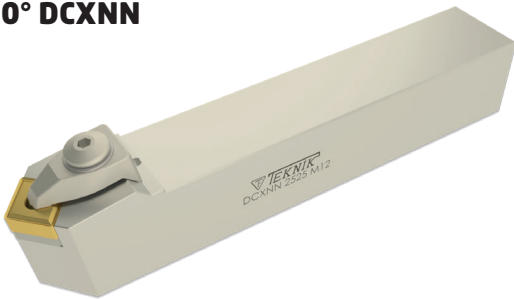

Sipariş Kodu Order Code Best.-Nr.	Stok/Stock/Lager	Ürün Kodu Product Code Produkt-Code	Ölçüler (mm) Dimensions (mm) Abmessungen (mm)						Kullanılan Uç Insert WSP	Baskı Civatası Locking Screw Verriegelungs Schraube	Altlık Shim U-Platte	Altlık Civatası Shim Screw U-Platte Schraube	Baskı Kepi Clamp Spannpratze	Yay Spring Feder	Pul Washer U-Scheibe	Anahtar Allen Key Inbuss-Schlüssel
			L	L1	h	f	b									
D216	●	DCXNN 2525 M12	150	35	25	12,5	25	0,756	CN-- 1204	TC044 M6	TA016	TC038 M4x10	BK020	BY040	BSP030	4 Allen