



# K2-SRC



PRAMET

S



## Copy and Profile End Mills

Flexible end mill for a wide range of Die & Mold applications. One tool solution for ball-nosed and toroidal inserts. Available in cylindrical and modular style, in range Ø8 up to Ø32 mm. Body treated for longer tool life.

APMX	0.6 - 3.2 mm
------	--------------

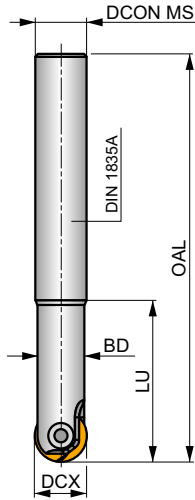
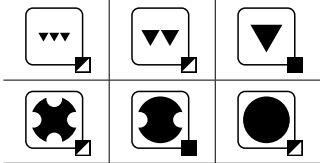
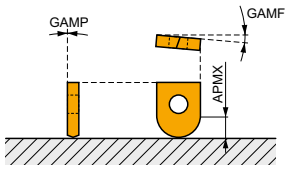

DCX 8 – 20 mm

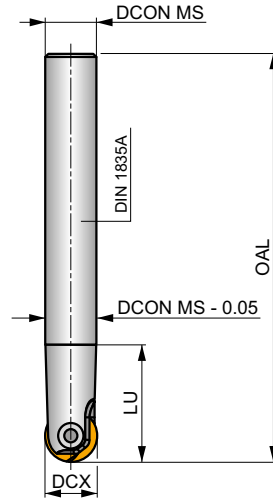

DCX 8 – 20 mm

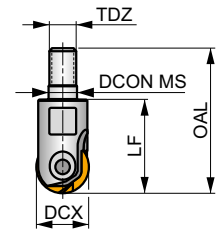

$h_m$  0.07 - 0.14



Product	DCX	OAL	DCON MS	BD	LU	LF	TDZ					kg		
	[mm]	[mm]	[mm]	[mm]	[mm]	[mm]								
08K2R025A10-SRC08-A	8	110	10	7.5	25	-	-	2	-	56000	-	0.09	GI030	C0530
08K2R050A12-SRC08-A	8	140	12	-	13.5	-	-	2	-	56000	-	0.11	GI030	C0530
10K2R030A12-SRC10-A	10	130	12	9	30	-	-	2	-	42000	-	0.11	GI031	C0531
10K2R060A16-SRC10-A	10	150	16	-	19.5	-	-	2	-	42000	-	0.18	GI031	C0531
12K2R030A12-SRC12-A	12	130	12	10.5	30	-	-	2	-	35000	-	0.11	GI032	C0532
16K2R035A16-SRC16-A	16	140	16	14	35	-	-	2	-	22000	-	0.23	GI033	C0533
20K2R045A20-SRC20-A	20	160	20	18	45	-	-	2	-	16000	-	0.40	GI034	C0534
25K2R045A25-SRC25-A	25	160	25	22.4	45	-	-	2	-	10000	-	0.59	GI035	C0535
32K2R060A32-SRC32-A	32	180	32	28.6	60	-	-	2	-	6000	-	1.10	GI036	C0536
12K2R060A16-SRC12-A	12	160	16	-	24.5	-	-	2	-	35000	-	0.14	GI032	C0532
16K2R065A20-SRC16-A	16	175	20	-	31.5	-	-	2	-	22000	-	0.41	GI033	C0533
20K2R080A25-SRC20-A	20	190	25	-	33.5	-	-	2	-	16000	-	0.66	GI034	C0534
08K2R30M06-SRC08-A	8	45	6.5	-	-	30	M6	2	-	-	-	0.02	GI123	C0530
10K2R30M06-SRC10-A	10	45	6.5	-	-	30	M6	2	-	-	-	0.03	GI124	C0531
12K2R30M06-SRC12-A	12	45	6.5	-	-	30	M6	2	-	-	-	0.16	GI125	C0530
12K2R30M08-SRC12-A	12	48	8.5	-	-	30	M8	2	-	-	-	0.04	GI125	C0532
16K2R35M08-SRC16-A	16	53	8.5	-	-	35	M8	2	-	-	-	0.05	GI033	C0533
20K2R35M10-SRC20-A	20	54	10.5	-	-	35	M10	2	-	-	-	0.08	GI034	C0534

GI030	RC 08	RC 08-F	LC 08-KP	LC 08-KPF	-	-
GI031	RC 10	RC 10-F	LC 10-KP	LC 10-KPF	-	-
GI032	RC 12	RC 12-F	-	-	LC 12..-CH	LC 12..-RE
GI033	RC 16	RC 16-F	-	-	-	-
GI034	RC 20	RC 20-F	-	-	-	-
GI035	RC 25	RC 25-F	-	-	-	-



GI036	RC 32	RC 32-F	-	-	-	-	-	-
GI123	RC 08	RC 08-F	-	-	-	-	-	-
GI124	RC 10	RC 10-F	-	-	-	-	-	-
GI125	RC 12	RC 12-F	-	-	-	-	-	-

C0530	CS 3007-T08P	1.2	M 3	7	-	-	-	Flag T08P
C0531	CS 4008-T15P	3.0	M 4	8	-	D-T08P/T15P	FG-15	-
C0532	CS 5009-T20P	5.0	M 5	9	SDRT 20P	-	-	-
C0533	CS 5013-T20P	5.0	M 5	13	SDRT 20P	-	-	-
C0534	CS 5015-T20P	5.0	M 5	15	SDRT 20P	-	-	-
C0535	CS 6020-T20P	7.5	M 6	20	SDRT 20P	-	-	-
C0536	CS 8025-T30P	15.0	M 8	25	SDRT 30P	-	-	-

## RC



	CDI	D1	INSL	S
	[mm]	[mm]	[mm]	[mm]
08	8.0	3.00	9.5	2.00
10	10.0	4.00	11.5	2.50
12	12.0	5.00	12.0	2.50
16	16.0	5.00	14.0	3.00
20	20.0	5.00	16.0	3.00
25	25.0	6.00	21.5	4.00
32	32.0	8.00	25.8	5.00

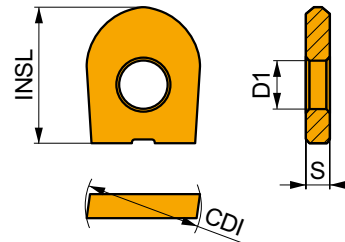

Suitability and starting values for cutting speed (vc), feed (f) and depth of cut (ap). Refer to our Machining Calculator app for further calculations.

Product	RE	P			M			K			N			S			H		
		vc	f	ap	vc	f	ap	vc	f	ap	vc	f	ap	vc	f	ap	vc	f	ap
	[mm]	[m/min]	[mm/tooth]	[mm]	[m/min]	[mm/tooth]	[mm]	[m/min]	[mm/tooth]	[mm]	[m/min]	[mm/tooth]	[mm]	[m/min]	[mm/tooth]	[mm]	[m/min]	[mm/tooth]	[mm]

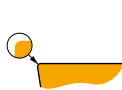

Neutral face with a positive cutting edge design.

RC 08	M4310	-	255	0.36	0.4	-	-	-	240	0.36	0.4	-	-	-	-	-	-	50	0.15	1.0
	M8310	-	295	0.36	0.4	-	-	-	280	0.36	0.4	-	-	-	-	-	-	55	0.15	1.0
	M8330	-	275	0.36	0.4	-	-	-	260	0.36	0.4	-	-	-	-	-	-	55	0.15	1.0
RC 10	M4310	-	250	0.36	0.5	-	-	-	235	0.36	0.5	-	-	-	-	-	-	50	0.15	1.0
	M8310	-	290	0.36	0.5	-	-	-	275	0.36	0.5	-	-	-	-	-	-	55	0.15	1.0
	M8330	-	270	0.36	0.5	-	-	-	255	0.36	0.5	-	-	-	-	-	-	50	0.15	1.0
RC 12	M4310	-	245	0.36	0.6	-	-	-	230	0.36	0.6	-	-	-	-	-	-	45	0.15	1.0
	M8310	-	285	0.36	0.6	-	-	-	270	0.36	0.6	-	-	-	-	-	-	55	0.15	1.0
	M8330	-	265	0.36	0.6	-	-	-	250	0.36	0.6	-	-	-	-	-	-	50	0.15	1.0
RC 16	M4310	-	235	0.36	0.8	-	-	-	220	0.36	0.8	-	-	-	-	-	-	45	0.15	1.0
	M8310	-	275	0.36	0.8	-	-	-	260	0.36	0.8	-	-	-	-	-	-	55	0.15	1.0
	M8330	-	255	0.36	0.8	-	-	-	240	0.36	0.8	-	-	-	-	-	-	50	0.15	1.0
RC 20	M4310	-	235	0.36	1.0	-	-	-	220	0.36	1.0	-	-	-	-	-	-	45	0.15	1.0
	M8310	-	270	0.36	1.0	-	-	-	255	0.36	1.0	-	-	-	-	-	-	50	0.15	1.0
	M8330	-	250	0.36	1.0	-	-	-	235	0.36	1.0	-	-	-	-	-	-	50	0.15	1.0
RC 25	M4310	-	225	0.36	1.3	-	-	-	210	0.36	1.3	-	-	-	-	-	-	45	0.15	1.0
	M8310	-	260	0.36	1.3	-	-	-	245	0.36	1.3	-	-	-	-	-	-	50	0.15	1.0
	M8330	-	245	0.36	1.3	-	-	-	230	0.36	1.3	-	-	-	-	-	-	45	0.15	1.0
RC 32	M4310	-	220	0.36	1.6	-	-	-	205	0.36	1.6	-	-	-	-	-	-	40	0.15	1.0
	M8310	-	240	0.36	1.6	-	-	-	225	0.36	1.6	-	-	-	-	-	-	45	0.15	1.0
	M8330	-	240	0.36	1.6	-	-	-	225	0.36	1.6	-	-	-	-	-	-	45	0.15	1.0



Suitability and starting values for cutting speed (vc), feed (f) and depth of cut (ap). Refer to our Machining Calculator app for further calculations.

Product	RE [mm]	P			M			K			N			S			H		
		vc [m/min]	f [mm/tooth]	ap [mm]	vc [m/min]	f [mm/tooth]	ap [mm]	vc [m/min]	f [mm/tooth]	ap [mm]	vc [m/min]	f [mm/tooth]	ap [mm]	vc [m/min]	f [mm/tooth]	ap [mm]	vc [m/min]	f [mm/tooth]	ap [mm]



F geometry is sharp and suitable for finish machining.

RC 08-F	M4310	–	✓	255	0.36	0.4	✓	130	0.32	0.4	■	240	0.36	0.4	–	–	–	–	–	–	–	■	50	0.15	1.0
RC 10-F	M4310	–	✓	250	0.36	0.5	✓	125	0.32	0.5	■	235	0.36	0.5	–	–	–	–	–	–	–	■	50	0.15	1.0
RC 12-F	M4310	–	✓	245	0.36	0.6	✓	120	0.32	0.6	■	230	0.36	0.6	–	–	–	–	–	–	–	■	45	0.15	1.0
RC 16-F	M4310	–	✓	235	0.36	0.8	✓	115	0.32	0.8	■	220	0.36	0.8	–	–	–	–	–	–	–	■	45	0.15	1.0
RC 20-F	M8330	–	■	255	0.36	0.8	✓	150	0.32	0.8	■	240	0.36	0.8	–	–	–	–	–	–	–	✓	50	0.15	1.0
	M4310	–	✓	235	0.36	1.0	✓	115	0.32	1.0	■	220	0.36	1.0	–	–	–	–	–	–	–	■	45	0.15	1.0
	M8330	–	■	250	0.36	1.0	✓	150	0.32	1.0	■	235	0.36	1.0	–	–	–	–	–	–	–	✓	50	0.15	1.0

## LC



	CDI [mm]	D1 [mm]	L [mm]	S [mm]
08	8.0	3.00	9.50	2.00
10	10.0	4.00	11.50	2.50
12	12.0	5.00	14.00	2.50
16	16.0	5.00	16.00	3.00
20	20.0	5.00	18.00	3.00

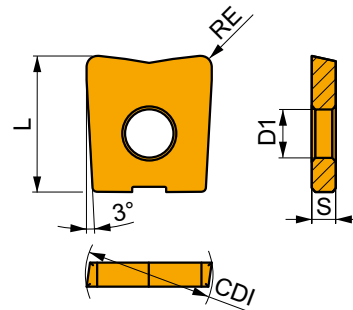

Suitability and starting values for cutting speed (vc), feed (f) and depth of cut (ap). Refer to our Machining Calculator app for further calculations.

Product	RE [mm]	P			M			K			N			S			H		
		vc [m/min]	f [mm/tooth]	ap [mm]	vc [m/min]	f [mm/tooth]	ap [mm]	vc [m/min]	f [mm/tooth]	ap [mm]	vc [m/min]	f [mm/tooth]	ap [mm]	vc [m/min]	f [mm/tooth]	ap [mm]	vc [m/min]	f [mm/tooth]	ap [mm]



KP geometry with zero rake angle design for light to medium machining.

LC 0806-KP	M4310	0.6	✓	280	0.16	0.3	–	–	–	■	265	0.16	0.3	–	–	–	–	–	–	–	■	55	0.15	1.0
	M8310	0.6	■	325	0.16	0.3	–	–	–	■	305	0.16	0.3	–	–	–	–	–	–	–	■	65	0.15	1.0
	M8330	0.6	■	295	0.16	0.3	–	–	–	■	280	0.16	0.3	–	–	–	–	–	–	–	✓	55	0.15	1.0
LC 0810-KP	M4310	1.0	✓	280	0.16	0.5	–	–	–	■	265	0.16	0.5	–	–	–	–	–	–	–	■	55	0.15	1.0
	M8310	1.0	■	325	0.16	0.5	–	–	–	■	305	0.16	0.5	–	–	–	–	–	–	–	■	65	0.15	1.0
LC 1008-KP	M4310	0.8	✓	270	0.16	0.4	–	–	–	■	255	0.16	0.4	–	–	–	–	–	–	–	■	50	0.15	1.0
	M8310	0.8	■	315	0.16	0.4	–	–	–	■	295	0.16	0.4	–	–	–	–	–	–	–	■	60	0.15	1.0
	M8330	0.8	■	290	0.16	0.4	–	–	–	■	275	0.16	0.4	–	–	–	–	–	–	–	✓	55	0.15	1.0
LC 1010-KP	M4310	1.0	✓	280	0.16	0.5	–	–	–	■	265	0.16	0.5	–	–	–	–	–	–	–	■	55	0.15	1.0
	M8310	1.0	■	325	0.16	0.5	–	–	–	■	305	0.16	0.5	–	–	–	–	–	–	–	■	65	0.15	1.0
	M8330	1.0	■	295	0.16	0.5	–	–	–	■	280	0.16	0.5	–	–	–	–	–	–	–	✓	55	0.15	1.0
LC 1210-KP	M4310	1.0	✓	280	0.16	0.5	–	–	–	■	265	0.16	0.5	–	–	–	–	–	–	–	■	55	0.15	1.0
	M8310	1.0	■	325	0.16	0.5	–	–	–	■	305	0.16	0.5	–	–	–	–	–	–	–	■	65	0.15	1.0
	M8330	1.0	■	295	0.16	0.5	–	–	–	■	280	0.16	0.5	–	–	–	–	–	–	–	✓	55	0.15	1.0
LC 1220-KP	M4310	2.0	✓	285	0.16	1.0	–	–	–	■	270	0.16	1.0	–	–	–	–	–	–	–	■	55	0.15	1.0
LC 1610-KP	M4310	1.0	✓	280	0.16	0.5	–	–	–	■	265	0.16	0.5	–	–	–	–	–	–	–	■	55	0.15	1.0
	M8310	1.0	■	325	0.16	0.5	–	–	–	■	305	0.16	0.5	–	–	–	–	–	–	–	■	65	0.15	1.0
	M8330	1.0	■	295	0.16	0.5	–	–	–	■	280	0.16	0.5	–	–	–	–	–	–	–	✓	55	0.15	1.0
LC 1613-KP	M4310	1.3	✓	270	0.16	0.7	–	–	–	■	255	0.16	0.7	–	–	–	–	–	–	–	■	50	0.15	1.0
	M8310	1.3	■	315	0.16	0.7	–	–	–	■	295	0.16	0.7	–	–	–	–	–	–	–	■	60	0.15	1.0
LC 1630-KP	M4310	3.0	✓	270	0.16	1.5	–	–	–	■	255	0.16	1.5	–	–	–	–	–	–	–	■	50	0.15	1.0
LC 2010-KP	M4310	1.0	✓	280	0.16	0.5	–	–	–	■	265	0.16	0.5	–	–	–	–	–	–	–	■	55	0.15	1.0
	M8310	1.0	■	325	0.16	0.5	–	–	–	■	305	0.16	0.5	–	–	–	–	–	–	–	■	65	0.15	1.0
	M8330	1.0	■	295	0.16	0.5	–	–	–	■	280	0.16	0.5	–	–	–	–	–	–	–	✓	55	0.15	1.0



Suitability and starting values for cutting speed (vc), feed (f) and depth of cut (ap). Refer to our Machining Calculator app for further calculations.

Product	RE (mm)	P			M			K			N			S			H		
		vc [m/min]	f [mm/tooth]	ap [mm]	vc [m/min]	f [mm/tooth]	ap [mm]	vc [m/min]	f [mm/tooth]	ap [mm]	vc [m/min]	f [mm/tooth]	ap [mm]	vc [m/min]	f [mm/tooth]	ap [mm]	vc [m/min]	f [mm/tooth]	ap [mm]



KP geometry with zero rake angle design for light to medium machining.

LC 2016-KP	M4310	1.6	280	0.16	0.8	—	—	—	265	0.16	0.8	—	—	—	—	—	—	—	55	0.15	1.0
	M8310	1.6	325	0.16	0.8	—	—	—	305	0.16	0.8	—	—	—	—	—	—	65	0.15	1.0	
LC 2040-KP	M8330	4.0	285	0.16	2.0	—	—	—	270	0.16	2.0	—	—	—	—	—	—	55	0.15	1.0	

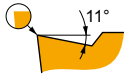
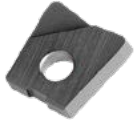

KPF geometry with positive design for light to medium machining.

LC 0806-KPF	M4310	0.6	280	0.16	0.3	140	0.14	0.3	265	0.16	0.3	—	—	—	—	—	—	55	0.15	1.0
LC 1008-KPF	M4310	0.8	270	0.16	0.4	135	0.14	0.4	255	0.16	0.4	—	—	—	—	—	—	50	0.15	1.0
LC 1210-KPF	M4310	1.0	280	0.16	0.5	140	0.14	0.5	265	0.16	0.5	—	—	—	—	—	—	55	0.15	1.0
	M8330	1.0	295	0.16	0.5	175	0.14	0.5	280	0.16	0.5	—	—	—	—	—	—	55	0.15	1.0
LC 1613-KPF	M4310	1.3	270	0.16	0.7	135	0.14	0.7	255	0.16	0.7	—	—	—	—	—	—	50	0.15	1.0
LC 2016-KPF	M4310	1.6	280	0.16	0.8	140	0.14	0.8	265	0.16	0.8	—	—	—	—	—	—	55	0.15	1.0

## LC 12-CH



CDI (mm)	D1 (mm)	L (mm)	S (mm)	
1245	12.0	5.00	14.00	2.50

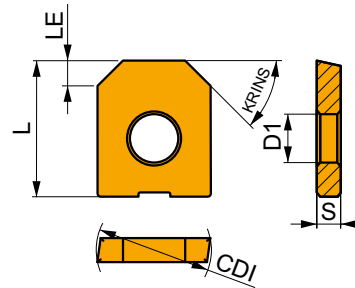

Suitability and starting values for cutting speed (vc), feed (f) and depth of cut (ap). Refer to our Machining Calculator app for further calculations.

Product	RE (mm)	P			M			K			N			S			H		
		vc [m/min]	f [mm/tooth]	ap [mm]	vc [m/min]	f [mm/tooth]	ap [mm]	vc [m/min]	f [mm/tooth]	ap [mm]	vc [m/min]	f [mm/tooth]	ap [mm]	vc [m/min]	f [mm/tooth]	ap [mm]	vc [m/min]	f [mm/tooth]	ap [mm]



CH geometry with zero rake angle design for light to medium machining.

LC 1245-CH	M4310	—	225	0.20	2.0	—	—	—	210	0.20	2.0	—	—	—	—	—	—	45	0.15	1.0
------------	-------	---	-----	------	-----	---	---	---	-----	------	-----	---	---	---	---	---	---	----	------	-----



# LC 12-RE

	CDI	D1	L	S
	[mm]	[mm]	[mm]	[mm]
12	12.0	5.00	14.00	2.50

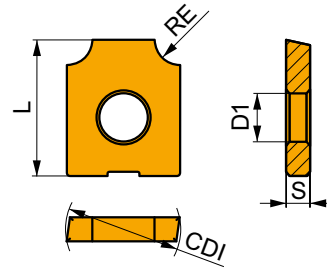

Suitability and starting values for cutting speed (vc), feed (f) and depth of cut (ap). Refer to our Machining Calculator app for further calculations.

Product	RE	P			M			K			N			S			H		
		vc	f	ap	vc	f	ap	vc	f	ap	vc	f	ap	vc	f	ap	vc	f	ap
	[mm]	[m/min]	[mm/tooth]	[mm]	[m/min]	[mm/tooth]	[mm]	[m/min]	[mm/tooth]	[mm]	[m/min]	[mm/tooth]	[mm]	[m/min]	[mm/tooth]	[mm]	[m/min]	[mm/tooth]	[mm]

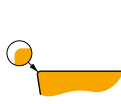

RE geometry with zero rake angle design for light to medium machining.

LC 1220-RE	M4310	2.0	295	0.10	2.0	—	—	—	280	0.10	2.0	—	—	—	—	—	—	—	55	0.15	1.0
LC 1230-RE	M4310	3.0	285	0.10	3.0	—	—	—	270	0.10	3.0	—	—	—	—	—	—	—	55	0.15	1.0



	RC 08	RC 10	RC 12	RC 16	RC 20	RC 25	RC 32
	4.0	5.0	6.0	8.0	10.0	12.5	16.0
	-	-	-	-	-	-	-



	RC 08-F	RC 10-F	RC 12-F	RC 16-F	RC 20-F
	4.0	5.0	6.0	8.0	10.0
	-	-	-	-	-

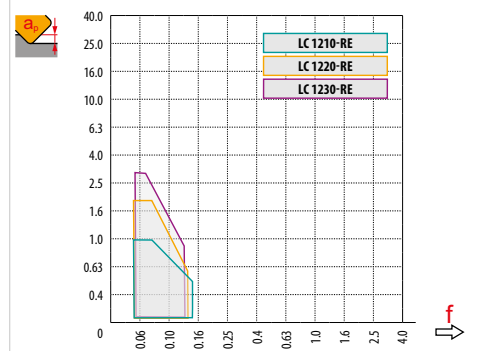
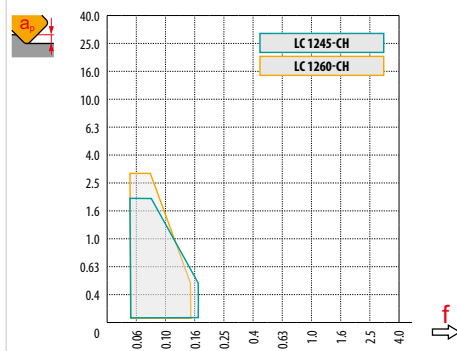
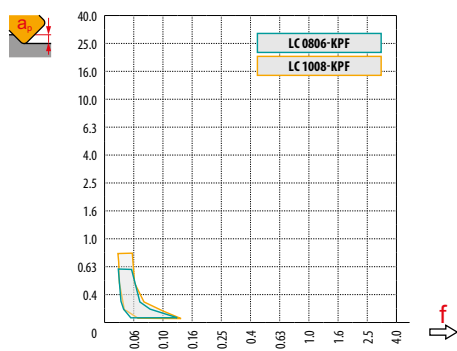
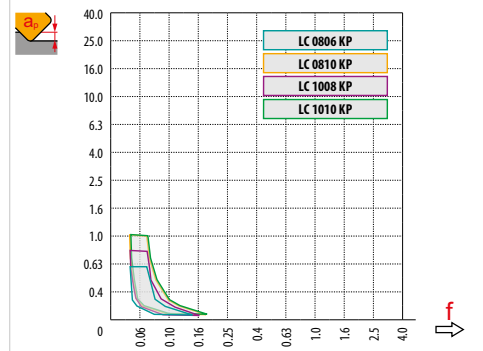
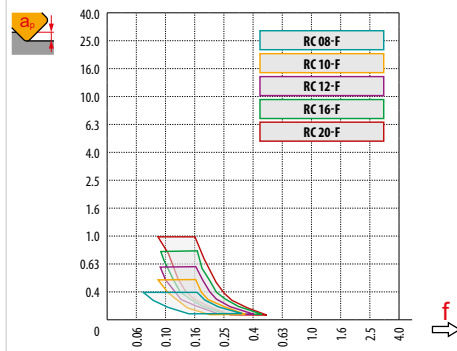
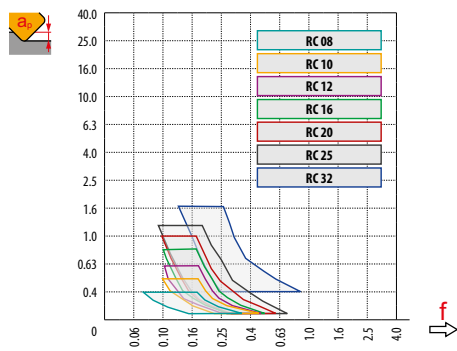

	LC 08-KP	LC 08-KP	LC 10-KP	LC 10-KP	LC 08-KPF	LC 10-KPF
	0.6	1.0	0.8	1.0	0.6	0.8
	-	-	-	-	-	-

	LC 1245-CH	LC 1260-CH	LC 1210-RE	LC 1220-RE	LC 1230-RE
	3×45	5×60	1.0	2.0	3.0
	-	-	-	-	-











	
RC 08 / RC 08-F	8
RC 10 / RC 10-F	10
RC 12 / RC 12-F	12
RC 16 / RC 16-F	16
RC 20 / RC 20-F	20
RC 25 / RC 25-F	25
RC 32 / RC 32-F	32

	0.3	0.4	0.5	0.7	1.0	1.25	1.5	2.0	2.5	3.0	4.0	5.0	6.0	8.0	10.0	12.0	15.0	16.0
	3.0	3.5	3.9	4.5	5.3	5.8	6.2	6.9	7.4	7.7	8.0	-	-	-	-	-	-	-
	3.4	3.9	4.4	5.1	6.0	6.6	7.1	8.0	8.7	9.2	9.8	10.0	-	-	-	-	-	-
	3.7	4.3	4.8	5.6	6.6	7.3	7.9	8.9	9.7	10.4	11.3	11.8	12.0	-	-	-	-	-
	4.3	5.0	5.6	6.5	7.7	8.6	9.3	10.6	11.6	12.5	13.9	14.8	15.5	16.0	-	-	-	-
	4.9	5.6	6.2	7.4	8.7	9.7	10.5	12.0	13.2	14.3	16.0	17.3	18.3	19.6	20.0	-	-	-
	5.4	6.3	7.0	8.2	9.8	10.9	11.9	13.6	15.0	16.2	18.3	20.0	21.4	23.3	24.5	25.0	-	-
	6.17	7.11	7.94	9.36	11.14	12.40	13.53	15.49	17.18	18.65	21.17	23.24	24.98	27.71	29.66	30.98	31.94	32.00



	
RC 08 / RC 08-F	8
RC 10 / RC 10-F	10
RC 12 / RC 12-F	12
RC 16 / RC 16-F	16
RC 20 / RC 20-F	20
RC 25 / RC 25-F	25
RC 32 / RC 32-F	32

	3	5	10	15	20	30	40	50	60	80	100
	0.310	0.400	0.566	0.693	0.800	0.980	1.131	1.265	1.386	1.600	1.789
	0.346	0.447	0.632	0.775	0.894	1.095	1.265	1.414	1.549	1.789	2.000
	0.379	0.490	0.693	0.849	0.980	1.200	1.386	1.549	1.697	1.960	2.191
	0.438	0.566	0.800	0.980	1.131	1.386	1.600	1.789	1.960	2.263	2.530
	0.490	0.632	0.894	1.095	1.265	1.549	1.789	2.000	2.191	2.530	2.828
	0.548	0.707	1.000	1.225	1.414	1.732	2.000	2.236	2.449	2.828	3.162
	0.620	0.800	1.131	1.386	1.600	1.960	2.263	2.530	2.771	3.200	3.578

	$a_e$	1.0%	2.5%	5.0%	7.5%	10%	15%	20%	25%	30%	35%	40%	45%	50%	60%	70%	75%	80%	90%	100%	
																					
19.9%	1.0%	2.86	1.84	1.33	1.12	1.00	0.89	-	-	-	-	-	-	-	-	-	-	-	-	-	
31.2%	2.5%	3.58	2.28	1.64	1.36	1.20	1.01	0.92	0.88	0.91	-	-	-	-	-	-	-	-	-	-	
43.6%	5.0%	4.22	2.68	1.92	1.58	1.39	1.16	1.03	0.95	0.90	0.88	0.89	-	-	-	-	-	-	-	-	
52.7%	7.5%	4.63	2.95	2.10	1.73	1.51	1.26	1.11	1.02	0.96	0.91	0.89	0.88	0.90	-	-	-	-	-	-	
60.0%	10.0%	4.94	3.14	2.24	1.84	1.61	1.33	1.18	1.07	1.00	0.95	0.91	0.89	0.88	1.00	-	-	-	-	-	
71.4%	15.0%	5.39	3.42	2.43	2.00	1.74	1.44	1.27	1.15	1.07	1.01	0.96	0.93	0.90	0.88	0.93	-	-	-	-	
80.0%	20.0%	5.70	3.62	2.57	2.11	1.84	1.52	1.33	1.21	1.12	1.05	1.00	0.96	0.93	0.89	0.88	0.89	1.00	-	-	
86.6%	25.0%	5.93	3.76	2.67	2.20	1.91	1.58	1.38	1.25	1.16	1.08	1.03	0.99	0.95	0.90	0.88	0.88	0.89	-	-	
91.7%	30.0%	6.10	3.87	2.75	2.26	1.96	1.62	1.42	1.28	1.18	1.11	1.05	1.01	0.97	0.92	0.89	0.88	0.88	0.93	-	
95.4%	35.0%	6.23	3.95	2.80	2.30	2.00	1.65	1.44	1.31	1.20	1.13	1.07	1.02	0.98	0.93	0.89	0.88	0.88	0.88	0.90	-
98.0%	40.0%	6.31	4.00	2.84	2.33	2.03	1.67	1.46	1.32	1.22	1.14	1.08	1.03	0.99	0.93	0.90	0.89	0.88	0.88	0.89	-
99.5%	45.0%	6.36	4.03	2.86	2.35	2.04	1.68	1.47	1.33	1.23	1.15	1.09	1.04	1.00	0.94	0.90	0.89	0.88	0.88	0.88	-
100.0%	50.0%	6.38	4.04	2.87	2.35	2.05	1.69	1.48	1.33	1.23	1.15	1.09	1.04	1.00	0.94	0.90	0.89	0.88	0.88	0.88	1.00

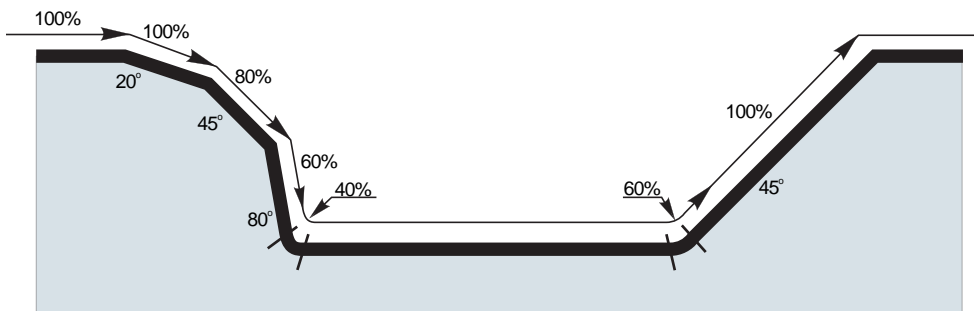



			0.00	0.30	0.40	0.50	0.60	0.70	0.80	0.90	1.00	1.25	1.50	2.00	2.50	3.00	4.00
LC 0806-KP	8	0.6	6.8	7.8	7.9	8.0	8.0	–	–	–	–	–	–	–	–	–	–
LC 0806-KPF		0.6	6.8	7.8	7.9	8.0	8.0	–	–	–	–	–	–	–	–	–	–
LC 0810-KP		1.0	6.0	7.4	7.6	7.7	7.8	7.9	8.0	8.0	8.0	–	–	–	–	–	–
LC 1008-KP	10	0.8	8.4	9.6	9.8	9.9	9.9	10.0	10.0	–	–	–	–	–	–	–	–
LC 1008-KPF		0.8	8.4	9.6	9.8	9.9	9.9	10.0	10.0	–	–	–	–	–	–	–	–
LC 1010-KP		1.0	8.0	9.4	9.6	9.7	9.8	9.9	10.0	10.0	10.0	–	–	–	–	–	–
LC 1245-CH	12	3×45	8.0	8.6	8.8	9.0	9.2	9.4	9.6	9.8	10.0	10.5	11.0	12.0	–	–	–
LC 1260-CH		5×60	9.7	10.0	10.2	10.3	10.4	10.5	10.6	10.7	10.8	11.1	11.4	12.0	–	–	–
LC 1210-RE		1.0	10.0	10.1	10.2	10.3	10.4	10.6	10.8	11.1	12.0	–	–	–	–	–	–
LC 1220-RE		2.0	8.0	8.0	8.1	8.1	8.2	8.3	8.3	8.4	8.5	8.9	9.4	12.0	–	–	–
LC 1230-RE		3.0	6.0	6.0	6.1	6.1	6.1	6.2	6.2	6.3	6.3	6.5	6.8	7.5	8.7	12.0	–



		3	5	10	15	20	30	40	50	60	80	100	
8		0.310	0.400	0.566	0.693	0.800	0.980	1.131	1.265	1.386	1.600	1.789	
		0.346	0.447	0.632	0.775	0.894	1.095	1.265	1.414	1.549	1.789	2.000	
RE		3	5	10	15	20	30	40	50	60	80	100	
		0.6	0.120	0.155	0.219	0.268	0.310	0.379	0.438	0.490	0.537	0.620	0.693
		0.8	0.139	0.179	0.253	0.310	0.358	0.438	0.506	0.566	0.620	0.716	0.800
1.0	0.155	0.200	0.283	0.346	0.400	0.490	0.566	0.632	0.693	0.800	0.89		



LC 0806-KP	8	0.6	3.0
LC 0806-KPF		0.6	2.8
LC 0810-KP		1.0	3.0
LC 1008-KP	10	0.8	3.8
LC 1008-KPF		0.8	3.6
LC 1010-KP		1.0	3.8
LC 1245-CH	12	3×45	–
LC 1260-CH		5×60	–
LC 1210-RE		1.0	–
LC 1220-RE		2.0	–
LC 1230-RE		3.0	–



LC 0806-KP	8	0.6	2.5	1.5/35
LC 0806-KPF		0.6	2.2	1.5/39
LC 0810-KP		1.0	2.4	1.5/36
LC 1008-KP	10	0.8	2.6	1.5/33
LC 1008-KPF		0.8	2.3	1.5/38
LC 1010-KP		1.0	2.6	1.5/33
LC 1245-CH	12	3×45	–	–
LC 1260-CH		5×60	–	–
LC 1210-RE		1.0	–	–
LC 1220-RE		2.0	–	–
LC 1230-RE		3.0	–	–





			DMIN	DMAX		
LC 0806-KP	8	0.6	9.8	15.9	0.8	1.0
LC 0806-KPF		0.6	10.2	15.9	0.1	0.1
LC 0810-KP		1.0	9.9	15.9	0.1	0.1
LC 1008-KP	10	0.8	12.2	19.9	0.9	1.1
LC 1008-KPF		0.8	12.6	19.9	0.2	0.2
LC 1010-KP		1.0	12.2	19.9	0.2	0.2
LC 1245-CH	12	3×45	–	–	–	–
LC 1260-CH		5×60	–	–	–	–
LC 1210-RE		1.0	–	–	–	–
LC 1220-RE		2.0	–	–	–	–
LC 1230-RE		3.0	–	–	–	–



LC 0806-KP	8	0.6	0.15
LC 0806-KPF		0.6	0.13
LC 0810-KP		1.0	0.13
LC 1008-KP	10	0.8	0.2
LC 1008-KPF		0.8	0.18
LC 1010-KP		1.0	0.19
LC 1245-CH	12	3×45	–
LC 1260-CH		5×60	–
LC 1210-RE		1.0	–
LC 1220-RE		2.0	–
LC 1230-RE		3.0	–



		Chamfer	Coefficient for speed	Feed for APMX		
LC 1245-CH	12	3 × 45	1.26	0.21		
LC 1260-CH		5 × 60	1.26	0.21		
<b>Overhang (multiple of diameter DCX)</b>		<b>&lt;3.0</b>	<b>3.0 – 3.5</b>	<b>3.6 – 4.0</b>	<b>4.1 – 4.5</b>	<b>&gt;4.6</b>
<b>Multiplication factor for speed</b>		1.0	0.9	0.8	0.7	0.5